

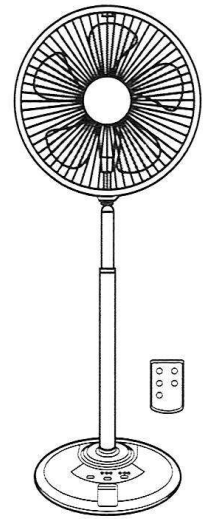

說明書 Operating Instructions

電風扇 (起居室電風扇) Electric Fan (Living Fan)



型號
Model number

N30NH

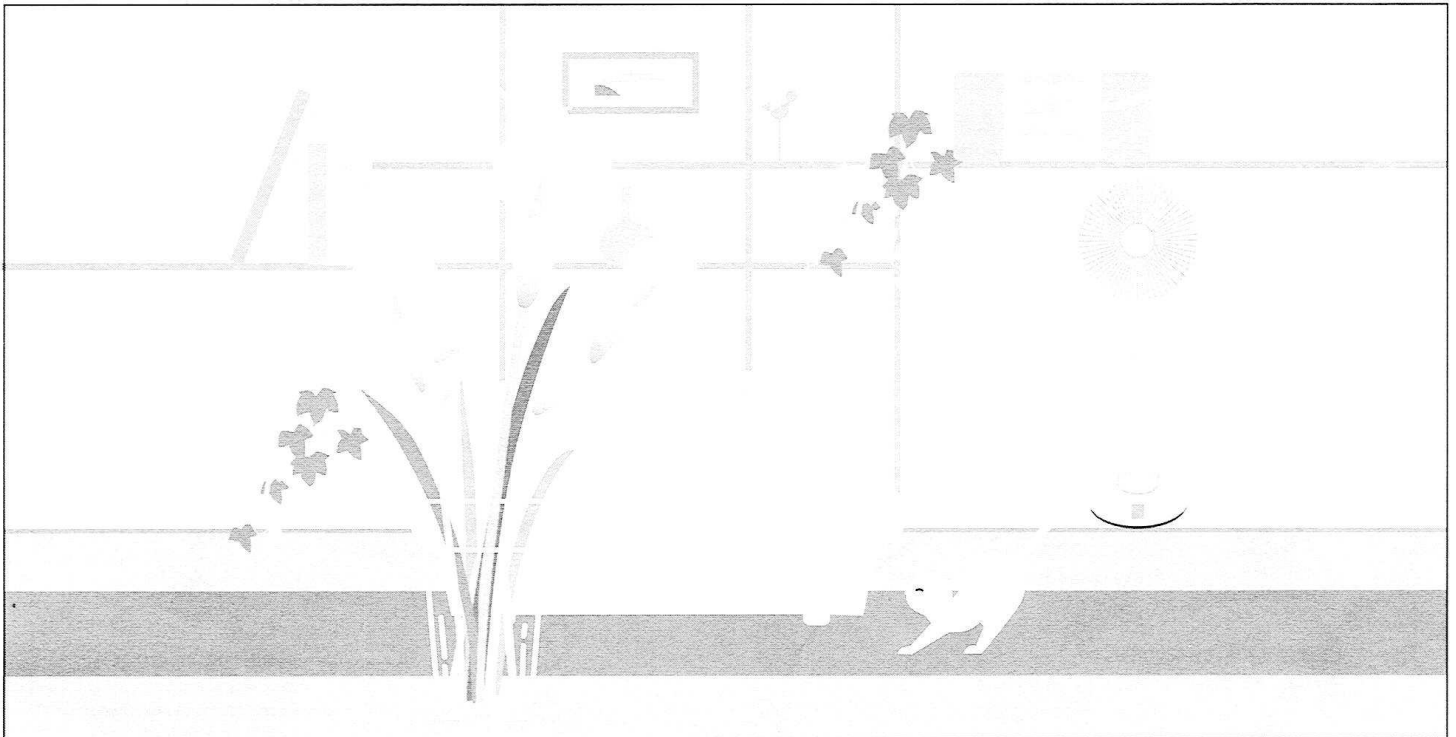

使用前務請詳細閱讀本書所載事項。
Before operating this set, please read these instructions completely.



只能使用額定電壓。
Use only with rated voltage.



如發現電源線損壞，請即連絡代理商或服務代理或特許技術人員以替換，以防備發生任何災害。
If the supply cord is damaged, it must be replaced by the manufacturer, its service agent or similarly qualified persons in order to avoid a hazard.



進行清洗或維修前必須先確定風扇的電源已經被關閉。
Ensure that the fan is switched off from supply main before cleaning or maintenance.



本設備是不打算供與（包括兒童）身體，感官或心理能力欠佳人士使用，或缺乏經驗和知識，除非他們是在負責他們安全的人員監督下或有關使用該設備的指示下使用。
This appliance is not intended for use by persons (including children) with reduced physical, sensory or mental capabilities, or lack of experience and knowledge, unless they have been given supervision or instruction concerning use of the appliance by a person responsible for their safety.



為了避免可能造成傷害用戶或損壞財產，請遵守以下所有的書面解釋。
製造商不會因有缺陷或不足的安裝所造成的意外及傷而亡負責。
To avoid the possibility of causing injury to users or damage properties, please follow all the explanation written below.
The manufacturer is not responsible for accidents and injuries caused by defective or deficient installation.



兒童應該受到監督以確保它們不玩該設備。
Children should be supervised to ensure that they do not play with the appliance.

感謝您選購此產品。
Thank you for purchasing this product.

安全注意事項 Safety precautions



請務必詳細閱讀及遵守安全指導
Be sure to read and follow these safety directions

請務必嚴格遵守以下說明之注意事項以防止對使用者或其他人造成傷害或財物損失。

Be sure to observe the following safety precautions in order to avoid possible injury to yourself or others and damage to your belongings.

■ 下列標記代表因不小心或錯誤使用有關欄目的內容而致不同程度的危險或損失。

The following symbols indicate the degree of possible danger if the relevant precautions are ignored.

	警告 Warning	有本標記之欄目表示「有可能造成重傷甚至死亡」之內容。 Fail to follow any of the directions marked with this symbol may result in serious injury or even death.
	小心 Caution	有本標記之欄目表示「有可能造成傷害或財物損失」之內容。 Fail to follow any of the directions marked with this symbol may result in injury or property damage.

■ 應遵守的事項有以下分類並由下列圖示來區分及說明。

Precautions are classified using the following symbols.

	這圖示表示「禁止」做的事。 This symbol indicates "you must not do".
	這圖示表示「必須」要做的事。 This symbol indicates "you must do".

警告 Warning

■ 切勿擅自拆散、修理或改造。

Never try to take apart, repair or modify this product.



禁止拆散

Do not take apart

會引致火災或觸電。

It may cause fire or electric shock.

• 若本品故障時請找經銷商修理。

Contact the dealer for repairing this product.

■ 不可接上 220/230V，50Hz 以外的電源。

Do not connect this unit to power supply other than 220/230V, 50Hz.



禁止

Prohibited

否則可能會引起火警。

Otherwise it may cause fire.

■ 扇葉或保護網未裝好時切勿開機。

Do not turn on the unit if blade or guard is not installed properly.



禁止

Prohibited

引致受傷。

Causing injury.

■ 裝配或拆除扇葉或保護網時不可
擰鬆高度調節鎖。

Do not loosen the height adjustment lock during assemble or remove blade and guards.



禁止

Prohibited

馬達及柱部可能會快速升高而擊傷使用者。
Motor and pole may rise rapidly and cause injury.

■ 確定電源插頭完全插入插座。

Make sure power plug is fully inserted into socket.



若插頭插得不好，可能會引致觸電或插頭過熱而造成火災。

Loose engagement of plug and socket may cause electric shock or fire due to overheating of the plug.

• 不要使用已損壞的插頭或鬆脫的插頭。

Do not use damaged plug or loosen socket.

■ 不可讓風扇沾水。

Do not contact with water.



禁止沾水
Avoid water

引起火災或觸電。

Causing fire or electric shock.

警告
Warning

- 勿令電線或插頭損壞。

Do not damage power cord or main plug.

例如對其加工、放在發熱器具附近、不正常地折曲或扭曲、強行拉長、負重、把電線捆成一扎。
e.g. modify, put near heat generating appliance, abnormally twist or bend, forcefully elongate, pull heavy weight, bundle up power cord.



禁止
Prohibited

引致受傷、觸電、甚至因短路引起火災。
Causing injury, electric shock or even fire due to short circuit.

為免造成傷亡，如電源線損壞必須送交其製造商或製造商指定的維修代理或類似的合資格人士作更換。
If the supply cord is damaged, it must be replaced by the manufacturer or its service agent or a similarly qualified person in order to avoid a hazard.

- 清潔前必須先切斷電源。

Disconnect power supply before cleaning.



拔掉插頭
Unplug

否則可能會引致觸電。

Otherwise it may cause electric shock.

- 手濕時切勿接觸電源插頭。

Never touch the plug if your hands are wet.



手濕不可觸碰
No wet hand

可能會引致觸電。
May cause electric shock.

- 要定期清除電源插頭及插座上之灰塵。

Wipe off dust on the plug and socket periodically.



如果電源插頭上積聚了灰塵，天氣潮濕時會容易引致絕緣不良而導致火災。
Accumulation of dust on plug in humid season may cause poor insulation and may result in fire.

- 請將電源插頭拔出，用乾布抹淨。
Disconnect from power supply and use a piece of dry cloth to clean the plug.
- 若長時期不使用風扇，請將電源插頭拔出。
Unplug the fan if it will not be used for a while.

小心
Caution

- 不要在以下場所使用風扇：

接近氣體爐具；有易燃氣體的地方；
有雨淋或容易被滴水的地方。

Do not use under the following situations:

Near to gaseous fuel cooker;
place full of inflammable gas;
place exposed to rain fall or water pour.



禁止
Prohibited

可能會吹熄爐火，引致漏氣及爆炸；
引致觸電、短路、火災。
May cause gaseous fuel leakage and explosion; Leading to electric shock, over heat, fire and explosion.

- 不要長時間把風扇吹著身體。

Avoid continuous exposure of direct wind from the fan.



禁止
Prohibited

導致身體不適。
It may cause discomfort.

- 切勿用手指插入網罩中或各可動部分。

Do not put your fingers into the guard or any moving part of the fan.



禁止接觸
Don't touch

引致受傷。
Causing injury.

- 不要把風扇放置在不平坦的地方或障礙物周圍。

Do not place the fan on unstable surface or near obstacles.



禁止
Prohibited

容易引致風扇倒下而導致受傷。
Risk on injury by falling fan.

- 要拔出電源插頭時，必須抓住電源插頭來拔，不能拉電源線。

Hold the plug when disconnect from main supply, never pull the cord.



可能會造成電線短路或斷線而引致火災或觸電。
May cause short circuit or damage of power supply cord and leading to fire or electric shock.

注意事項

- 不要把風扇放在接近殺蟲劑、油或腐蝕性物品的地方使用（引致風扇變質或損壞）。
Do not put the fan at a place where near insecticide, oil corrosive solvent (bad effect in quality and causing damages).
- 不要把風扇放在高溫、濕度高或塵埃多的地方使用（引致風扇變質或損壞）。
Do not put the fan in high temperature, high humidity or dusty place (bad effect in quality and causing damages).
- 勿掩蓋遙控接收器（導致不能用遙控器操作）。
Avoid covering the receptor (causing Remote Control Unit not functioning).
- 勿將液體潑濺在遙控器上、讓其由高處跌落或踐踏遙控器。（導致遙控器損壞）
Do not spill liquid on the Remote Control Unit. Do not drop or step on it. (Causing damage)

如何裝配 How to assemble

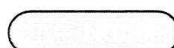
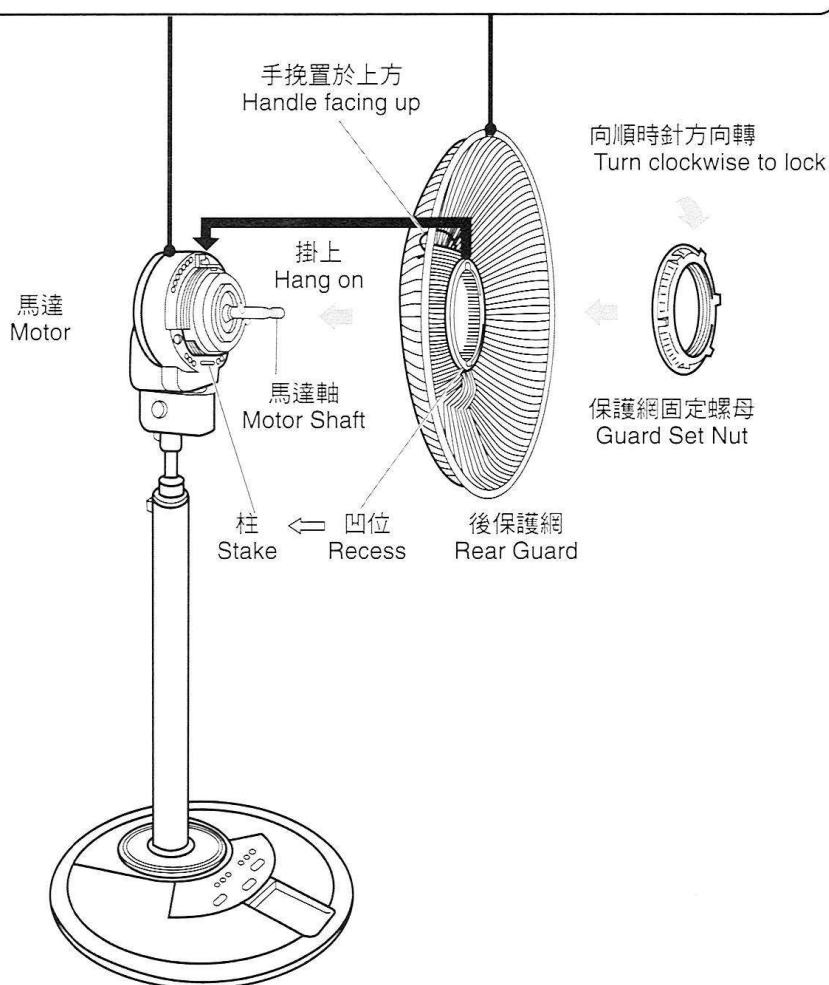
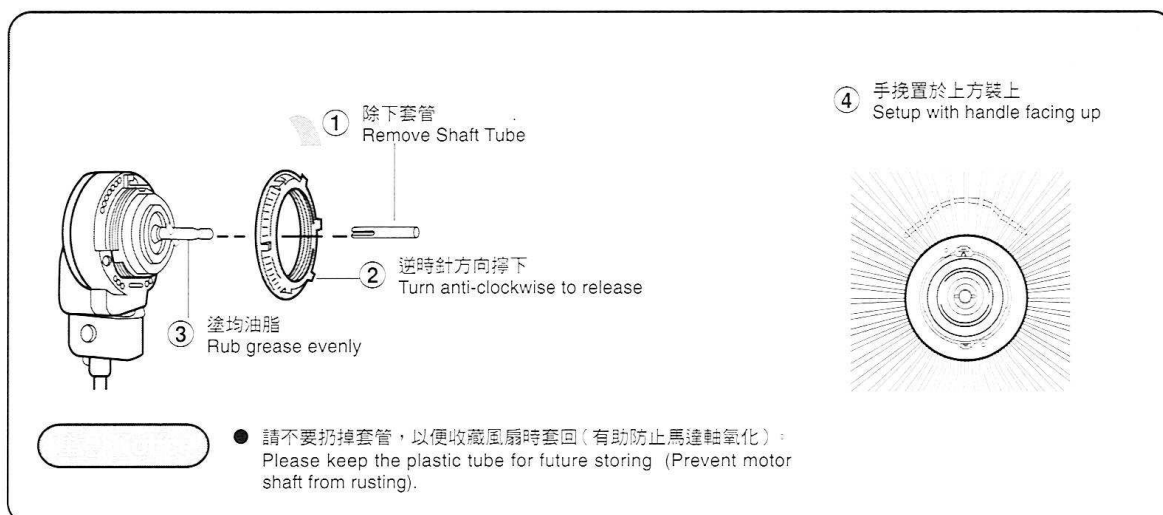

- 請確保擰緊保護網固定螺母和旋蓋以防在使用中鬆脫。
Please tighten the guard set nut and spinner firmly to prevent them from loosening.

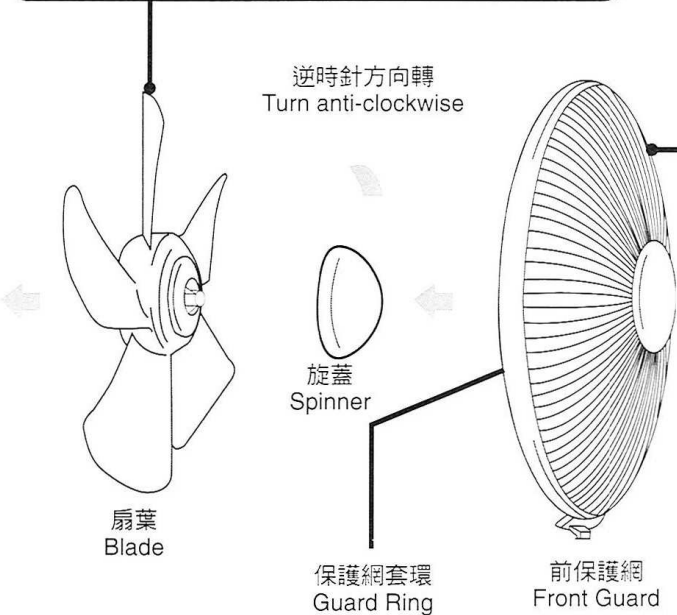
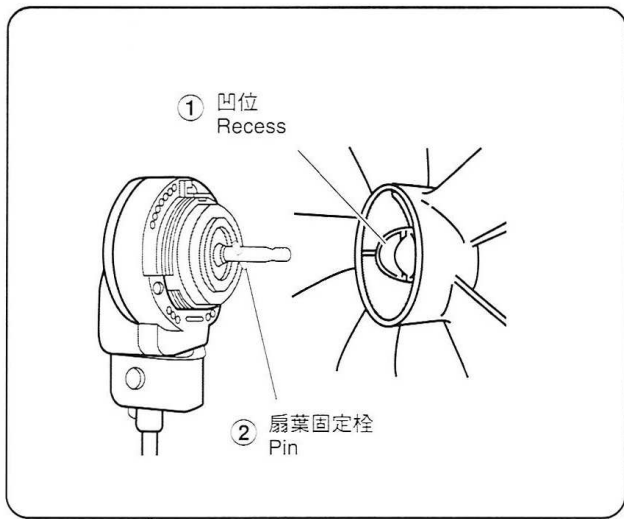

(電池附於遙控器上 Batteries are wrapped with remote-controller)

- 1 打開蓋子
Remove cover
- 2 裝上R03, LR03, AAA 電池
(注意正負極必須正確)
Install battery R03, LR03, AAA (Make sure the polarities are correct)
- 3 裝回蓋子
Install cover

- 電池使用壽命約一年 (實際壽命會因應使用的情況而有改變)
Battery life is around one year (battery life may vary depends on usage)
- 不要把新舊或型號不同的電池混合使用
Do not mix new and old batteries together or use different kinds of batteries
- 不要使用充電電池
Do not use rechargeable batteries
- 長時間不使用遙控器時請取出電池
If the fan is not going to be used for a long time, remove batteries.

- 1 前後保護網對位
Match front and rear guards
- 2 用雙手將前後保護網罩卡入
Snap the front and rear guards together with both hands
- 3 卡入環扣
Press on the clip

注意事項

- 為免保護網在使用時會鬆脫，請確保前後保護網扣緊。
To prevent the guards from loosening, please snap firmly.
- 如果保護網套環由前保護網脫落
If guard ring falls out from front guard

- 1 將「配合標記」扣入爪部
Place the "Marked spot" directly under the notch
- 2 將餘下的爪全部扣上
Clip on all remaining notches
- 3 確保按下環扣直至發出喀喀聲以完全將環扣鎖上。
Please ensure to press Guard Clip until two clicking sound is heard to fully lock the Guard Clip.

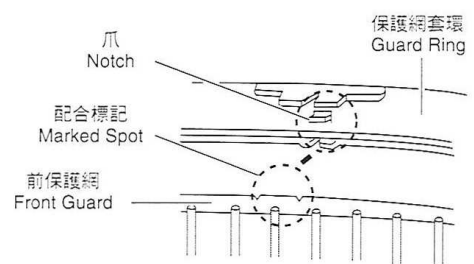

使用方法 How to operate

左右調節
Adjust horizontally

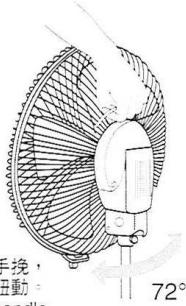

用手握著手柄，然後左右扭動。Hold the handle, then turn left or right.

上下調節
Adjust vertically

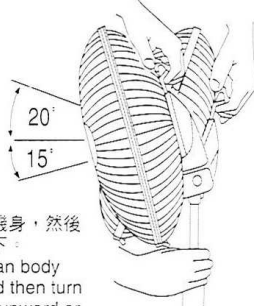

扶緊風扇機身，然後拉上或按下。Hold the fan body tightly, and then turn the motor upward or downward.

若風扇未能停在你想調較的位置，請作以下調較：
If the fan cannot stop at the position which has been adjusted by you, please do the following steps:

除下後網罩及後網罩固定螺母。
Take off rear guard and guard set nut.

⊖ 螺絲批
Screwdriver
(用來把蓋子拿出)
(To take off the cap)



蓋子
Cap
(壓入式)
(Press to cover)

⊕ 螺絲批
Screwdriver

用螺絲批和運用適當的手力扭轉以將其鎖緊。
Use the Screwdriver and screw it firmly by applying adequate amount of hand torque.

保護網套環
Guard Ring

前保護網
Front Guard

扇葉
Blade

後保護網
Rear Guard

升降柱
Slide Pipe

柱
Pole

操作面板
Control Panel

訊器
Receptor

遙控器
Remote Controller

底座
Base

在調較高度後，請把高度調節鈕扭緊。
Tighten the height adjustment screw after adjustment.

鬆 Loosen

緊 Tighten

高度調節鈕
Height adjustment screw

壓下遙控器尾部，然後取出遙控器。
(遙控器即使放於底座上仍可使用。)

Press the end of the remote controller, and then pick it up.
(The remote controller can also be used to control the fan when it is placed on the base.)

- 不用時，請把遙控器放回底座。
- Place the controller back to the base when not using the fan.

PUSH

推
PUSH

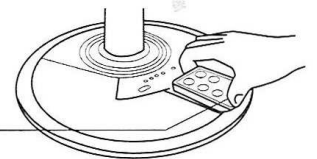

在扔棄遙控器作循環再造前請先除去所有乾電池。
Please remove any battery before disposing the remote controller for recycle.

使用方法 How to operate

- 若長時間不使用風扇時拔掉電源插頭以節省能源（即使在關機狀態風扇仍會消耗著 2W 的電能）
In order to save energy, disconnect this unit from power source if it will not be used for a long period. (The fan consumes about 2W power even at "OFF" mode)
- 每次按掣時風扇均會發出「嗶」一聲以表示轉換操作模式。
When any of the buttons is pressed, the fan will make a "beep" sound to indicate the change of operating mode.
- 有時風扇會因承托面凹凸不平而震動並發出雜聲，這時請略為移動風扇的位置或調較風扇的高度直到風扇不再震動及發出雜聲。
The fan may vibrate and make a loud noise if the supporting surface is not flat or level. If this happens, please move the fan a little bit or adjust its height until the vibration and noise stop.

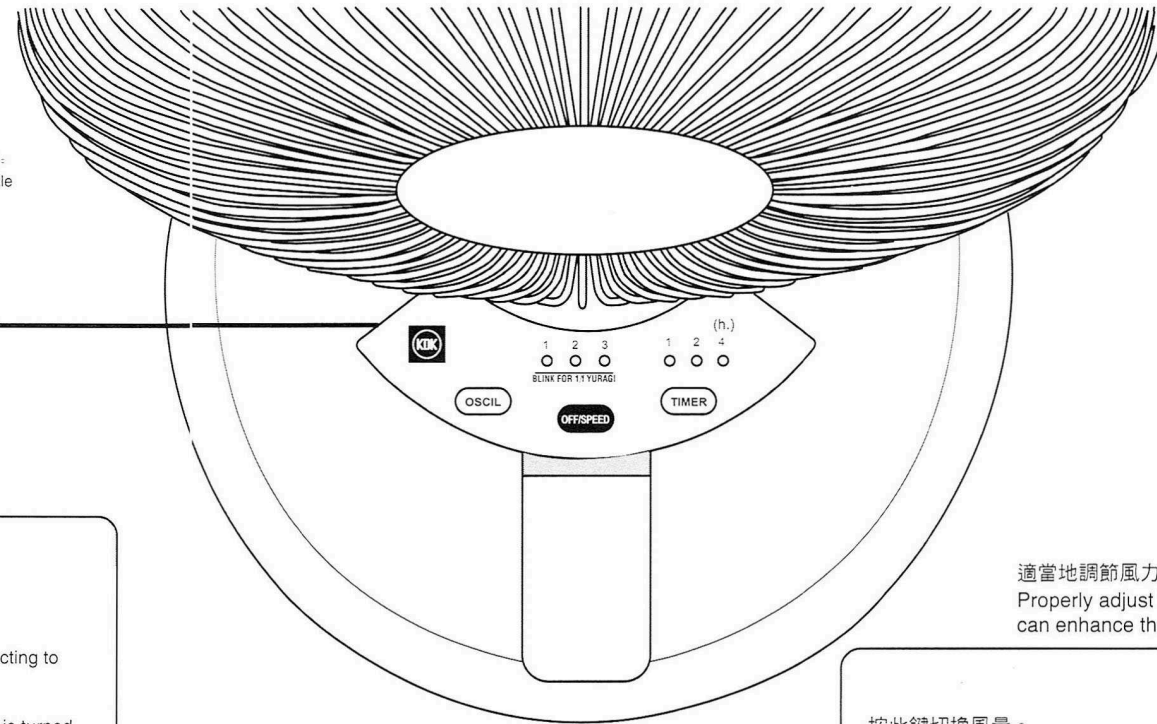

OFF•SPEED

每按此鍵一次風扇會依上圖的次序循環變換風速或停止
Press the button to change the fan speed or to turn it off as shown in the above diagram

TIMER

每按一次此鍵風扇會如上圖所示變換時間掣的設定
Press this button to set the timer as shown in the above diagram

OSCIL.

按此鍵可轉換搖頭 / 不搖頭的狀態
Press to toggle the status of fan oscillation

1/f YURAGI

- 「自然風」功能不能在操作面板啟動
"1/f YURAGI" function cannot be activated from control panel
- 在正常情況下操作面板的溫度在待機狀態時會較室溫高出約攝氏 10 度（因為機內的電路板在待機狀態時仍有少量電流通過）
It is normal that the temperature of control panel is about 10°C higher than ambient temperature. (There is a very low current flow through control circuit in standby mode)

與空調配合使用能有效節能
Using with air-conditioner can save energy.

每按鍵一次切換開關狀態
Press to toggle OFF/ON

- 第一次接通電源後，開始是慢檔。
The speed is "Low" at the first time after connecting to power supply.
- 風扇未開時其他按掣沒有作用。
Other buttons will not functioning when the fan is turned off.
- 開機時風扇會發出一聲短的「嗶」；而關機時則會發出一聲長的「嗶- - -」。
There will be a short "beep" when the fan is turned on and a long "beep" when turn off.

記憶功能 Memory function

- 關機後再次開機，運轉狀態和關機前相同。
When the fan is turned on by remote controller, it operates at previously set mode.
- 時間掣並無記憶功能。
No memory function for "Timer".
- 切斷電源後記憶會消失。
Memory will be cleared when the power supply is switched off.

適當地調節風力及啟動風扇搖頭能增強涼快感覺。
Properly adjust wind speed and activate oscillation can enhance the cooling effect.

按此鍵切換風量。
Press this button to change wind speed.

- 將遙控器對準受訊器。
Point the controller to the receptor.
- 遙控有效範圍為風扇正面 4.5m 及左右 50 度以內。
The controllable distance is about 4.5m from the fan within 50 degree.
- 按掣後遙控器無信號發出時請更換電池。
If remote control unit becomes ineffective, replace batteries.
- 請勿讓日光或強光直接照射遙控接收器（導致遙控失效）
Keep receptor out of direct sunlight and strong artificial light. (diminishes remote control unit effectiveness)

善用不同的風量、時間掣和自然風的組合能令使用者倍感舒適。
Use different combinations of speed, timer setting and "1/f YURAGI" function to achieve most comfortable feeling.

"1/f YURAGI" 推 Push

- 為吹出的風入柔和的氣氛，使舒適的風顯得更自然。（"1/f YURAGI": 燈亮起）
Comfortable and natural breeze generated through smooth increase of air flow. ("1/f YURAGI": lamp blink).

按此鍵一次轉換搖頭 / 不搖頭的狀態
Press to toggle the status of fan oscillation

- 開始搖頭時風扇會發出一聲短的「嗶」；停止搖頭時則會發出一聲長的「嗶- - -」。
There will be a short "beep" when turn on the fan and a long "beep" when turn off.

適當地使用時間掣即可省電又可避免睡著時著涼。
Properly use of Timer can save energy and prevent user from discomfort.

每按一次時間掣如下圖所示變換時間掣的設定。
Press this button to set the timer as shown below.

- 指示燈會隨剩餘時間減少而改變。
Indicating lamp will change accordingly as remaining time reduces.

清洗、維修和儲存 Cleaning, maintenance and storage



拔掉插頭
Unplug

■ 清潔前必須先切斷電源。
Disconnect power supply before cleaning.

否則可能會引致觸電。
Otherwise it may cause electric shock.

請用曾浸於中性清潔劑的柔軟濕布擦洗扇葉和機身，再用乾布抹乾。
Use soft cloth soaked in warm water with mild detergent to clean the blade and fan body.



- 防止刮花塑膠部份，請不要用乾布大力擦拭。
- 防止機身變質、變色，請不要用稀釋劑、石油精、酒精、去污粉、鹼性清潔劑等清洗。
- 使用化學抹布時，請先詳閱其使用說明。
- Rubbing too heavy with dry cloth may scratch the surface of plastic parts.
- Do not use thinner, benzene, alcohol, cleaning powder, alkaline detergent, etc.
- When using chemically treated cloth, follow its instructions.



禁止
Prohibited



電壓 Voltage (V~)	頻率 Frequency (Hz)	耗電量 Power (W)	轉速 r.p.m. (r/min.)	風速 Air Velocity (m/min.)	風量 Air Volume (m ³ /min.)	搖頭角度 Oscillation	電線長度 Cord Length (m)	重量 Weight (kg)	尺寸 Dimension (mm)
220	50	37	1039	181	40	0°, 70°	2	4.6	高 H 910 ~ 1045 闊 W 376 深 D 340
230	50	40	1085	189	42	0°, 70°	2	4.6	